

The power behind competitiveness

# Delta UPS - Amplon Family

N Series, Single Phase  
1/2/3 kVA

User Manual

[www.deltapowersolutions.com](http://www.deltapowersolutions.com)



## Save This Manual

This manual contains important instructions and warnings that you should follow during the installation, operation, storage and maintenance of this product. Failure to heed these instructions and warnings will void the warranty.

Copyright © 2012 by Delta Electronics Inc. All Rights Reserved. All rights of this User Manual ( "Manual" ), including but not limited to the contents, information, and figures are solely owned and reserved by Delta Electronics Inc. ( "Delta" ). The Manual can only be applied to the operation or the use of this product. Any disposition, duplication, dissemination, reproduction, modification, translation, extraction, or usage of this Manual in whole or in part is prohibited without the prior written permission of Delta. Given that Delta will continuously improve and develop the product, changes may be made to the information in this Manual at any time without obligation to notify any person of such revision or changes. Delta will make all possible efforts to secure the accuracy and the integrity of this Manual. Delta disclaims any kinds or forms of warranty, guarantee, or undertaking, either expressly or implicitly, including but not limited to the completeness, faultlessness, accuracy, non-infringement, merchantability or fitness for a particular purpose of the Manual.

# CONTENTS

<b>Chapter 1. IMPORTANT SAFETY INSTRUCTIONS.....</b>	<b>1</b>
1-1 safety instructions.....	1
<b>Chapter 2. INTRODUCTION .....</b>	<b>3</b>
2-1 Theory of operation .....	3
2-2 Feature .....	4
2-3 Annotation and symbol.....	6
2-4 Front Panel.....	7
2-5 Operation Panel .....	7
2-6 Rear Panel.....	9
<b>Chapter 3. INSTALLATION .....</b>	<b>10</b>
3-1 Unpacking.....	10
3-2 Before Installation.....	10
3-3 Installation.....	11
<b>Chapter 4. OPERATION.....</b>	<b>15</b>
4-1 Cold start when utility is not present .....	15
4-2 Turning "ON" the UPS.....	15
4-3 Turning "OFF" the UPS .....	15
4-4 UPS self-test.....	16
4-5 Silence function .....	16
4-6 Abnormal Condition.....	16
4-7 UPS internal fault.....	18
4-8 Derating power .....	18
<b>Chapter 5. MAINTENANCE .....</b>	<b>19</b>
<b>Chapter 6. PLACEMENT.....</b>	<b>19</b>
<b>Chapter 7. TROUBLESHOOTING .....</b>	<b>20</b>
<b>Chapter 8. COMMUNICATION INTERFACE.....</b>	<b>21</b>
8-1 RS-232 .....	21
<b>Chapter 9. Technical specifications.....</b>	<b>22</b>

# 1. IMPORTANT SAFETY INSTRUCTIONS

## 1-1 safety instructions

**Please observe the following precautions to ensure personnel safety and reliable equipment operation:**

- The sound pressure level at the operators position according to IEC 704-1:1982 is equal or less than 70dB(A).
- Der arbeitsplatzbezogene Schalldruckpegel dieses Gerätes nach DIN 45635 beträgt 70dB (A) oder weniger.

**For installation:**

- The unit should be installed from service personnel.
- Dieses Gerät ist durch Elektrofachkräfte zu installieren.
  
- Upon installation, it should be ensured that the sum of the leakage current of the UPS and the connected consumer does not exceed 3.5mA.
- Bei der Installation dieses Gerätes ist darauf zu achten, daß die Ableitströme der USV und der angeschlossenen Verbraucher den Maximalwert von 3.5 mA nicht überschreiten.
  
- The socket-outlet shall be near the equipment and easily accessible.
- Die Gerätesteckdose muß nahe dem Gerät angebracht und leicht zugänglich sein.

**Other safety instructions:**

- The UPS contains voltages which are potentially hazardous. All repairs should be performed by qualified service personnel. The UPS has its own internal energy source (Battery). The output receptacles may be alive even when the UPS is not connected to the mains.
- Die USV enthält Spannungen die möglicherweise gefährlich sind. Alle Reparaturen sollten nur von ausgebildeten Monteuren durchgeführt werden. Die USV hat eine interne Stromversorgung (Batterien). Die Ausgangsanschlüsse können daher unter Strom stehen auch wenn die USV nicht an das Versorgungsnetz angeschlossen ist.
  
- When replacing batteries, always use the same type and quantity as the previous one. Batteries of:

GES302N / 3KVA: HR9-12 (BB), HR1234WF2 (CSB)

GES202N / 2KVA: GP1270 or GP1272F2(CSB), BP7-12 or  
BP7.2-12 (BB), NP7-12 (Yuasa), RT1270 (Ritar)

GES102N / 1KVA: GP1270 or GP1272F2 (CSB), BP7-12 or  
BP7.2-12 (BB), NP7-12 (Yuasa), RT1270 (Ritar)

- Falls Sie die Batterien austauschen, verwenden Sie bitte ausschließlich die gleiche Anzahl und die folgenden Batterietypen:

GES302N / 3KVA: HR9-12 (BB), HR1234WF2 (34W)

GES202N / 2KVA: GP1270 or GP1272F2(CSB), BP7-12 or  
BP7.2-12 (BB), NP7-12 (Yuasa), RT1270 (Ritar)

GES102N / 1KVA: GP1270 or GP1272F2 (CSB), BP7-12 or  
BP7.2-12 (BB), NP7-12 (Yuasa), RT1270 (Ritar)

- Do not dispose the battery or batteries in fire as this may explode.
- Werfen Sie niemals die Batterien in das Feuer, die Batterien könnten explodieren.
- Do not open or mutilate the battery or batteries as released electrolyte is toxic and harmful to skin and eyes.
- Öffnen oder beschädigen Sie nicht die Batterien, ausfließendes Elektrolyt ist schädlich für Haut und Augen.
- A battery can present a risk of electric shock and high short circuit current. The following precaution should be observed when working on batteries.
  - \* Remove watches, rings or other metal objects.
  - \* Use tools with insulated handles.
- Eine Batterie kann eine Gefahr eines elektrischen Schlages und sehr großer Kurzschlussströme beinhalten. Folgende Vorkehrungen sollten getroffen werden, wenn Sie mit der Batterie arbeiten.
  - \* Entfernen Sie Uhren, Ringe und andere metallische Objekte.
  - \* Verwenden Sie Werkzeug mit isolierten Griffen.
- The equipment is to be operated by fully trained personnels.
- Diese Gerät ist nur durch unterwiesenes Personal zu bedienen.

#### **EC conformity declaration:**

It is herewith confirmed to comply with the requirements set out in the Council Directive on the Approximation of the Laws of the Member States relating to Electromagnetic Compatibility Directive (2004/108/EC) and Low Voltage Directive (2006/95/EC). For the evaluation of the compliance with these Directives, the following standards were applied:

- EN 62040-1:2008
- EN 62040-2:2006

## 2. INTRODUCTION

### 2-1 Theory of operation

The main topology of the UPS consists of bypass path, AC-DC converter, DC-AC inverter, battery charger, DC-DC converter, control circuit and detection circuit. Moreover, the intelligent power management software is also optional. The function and efficiency are superior to the traditional UPS.

Description of block diagram

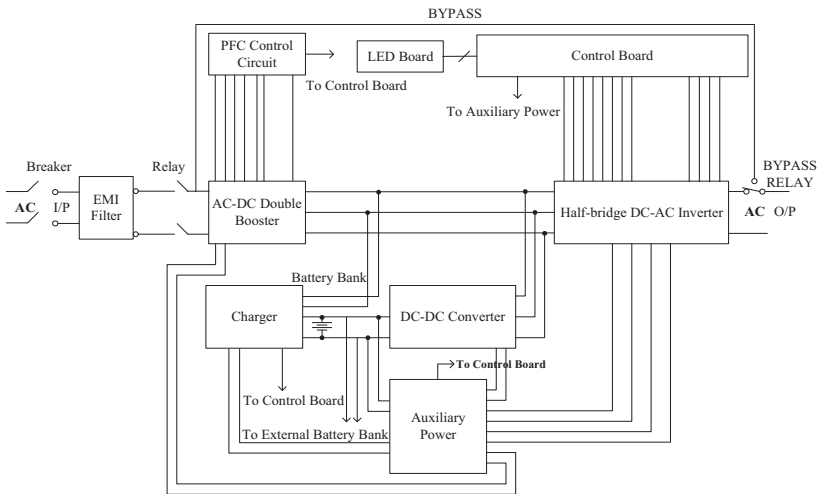

Fig. 2.1 is the hardware block diagram of the UPS.

**The UPS operation is described as below:**

When the utility power is applied into the UPS, it was divided into two ways after going through the breaker and EMI filter. One way is connected to AC-DC converter which converts the utility AC power into a DC voltage which is called DC-BUS voltage then divide into two path. One path goes to charger which converts the DC-BUS voltage into a proper DC voltage to charge the UPS battery. The other path goes into DC-AC half bridge inverter. The other way works as a bypass path. The bypass relay near the output will choose either the bypass path or inverter output. In general, the UPS will internally do the self-diagnosis. If there is no problem, the bypass relay will choose the inverter output. This is so called **【ON-LINE mode】** .

In case the utility power fail, the AC-DC converter and charger will be off duty. The DC-DC converter works and converts the battery voltage into DC-BUS voltage. The DC-AC inverter converts the DC-BUS voltage into AC voltage. This is so called **【ON-BATTERY mode】** .

The auxiliary power circuit supplies the designated power to all the control circuits. Because the DC-AC inverter is always working, the DC-DC converter can work rapidly and replace the AC-DC converter while the utility power fails. Furthermore, the bypass relay continuously keeps in the position of inverter output to supply the regulated power for the load. There is no power failure to loading equipment.

## **2-2 Feature**

The UPS, available in 1KVA, 2KVA and 3KVA, is an advanced on-line UPS providing reliable and consistent sine-wave quality power to vital equipment. It supports personal computers, networks, servers, telecommunication equipment and a variety of other facilities. With its outstanding protection features, the unit keeps your applications safe and running smoothly at all times.

### **PFC (Power Factor Correction)**

With this function, the investment in the capacity of circuit breakers can be reduced, specially it will be highly regarded as an important feature in critical load applications.

### **Complete Protection**

On-line double conversion design, pure sine wave output and zero transfer time provide best protection. With a built-in surge, spike and line noise protection, the UPS prevents destructive hardware damage and extends system life. The EMI/RFI filtering design prevents electrical noise from affecting computer operation and data files. Besides, the UPS provides built-in Fax/ Network cable (RJ11/RJ45) jacks protecting your hardware from surge, spikes and line-noise that travel along communication lines, therefore providing you a complete “back door” protection.

### **Intelligent design**

Integrated with a microprocessor, the UPS is able to perform intelligent functions. The UPS triggers over-voltage protection function and transfers to **【On- Battery mode】**even when utility voltage exceeds 280V for 220V Series. In addition, the UPS can accept large voltage variation of 80V to 280V. Wide input voltage range means less battery power usage frequency and longer battery life-span. Besides, programmable outlet design, suitable for power management, is also included in this unit.

### **Green function design**

The operation in sleeping mode is designed to just keep charging which saves the energy a lot.

### **User friendly interface**

The UPS provides a variety of functions which meet users' needs. Users can instantly understand the status of the UPS via the informative LED display. Audible alarms, bar meters and status indicators, such as battery replace indication, UPS fault, line condition, overload etc. are simple and easy for user to understand. Moreover, users can simply reset the circuit breaker instead of having to replace a fuse in the event of output overload.

### **Safety approvals**

The UPS has passed various safety regulations. CE mark and other safety approvals, proves that the UPS is a safe reliable solution to your power problems.

### **Network Management**

Build-in communication interface port supporting RS232 protocols enhances the reliability and manageability of the UPS over all major operating systems, including Windows 95/98, Windows NT, Netware, Unix, and others.



## 2-3 Annotation and symbol

The two signs shown on the manual indicating important instruction need to be followed.



Read before Operation



Maybe Dangerous/Follow Instructions



**PROTECTIVE GROUNDING TERMINAL:** A terminal which must be connected to earth ground prior to making any other connection to the equipment.



This symbol indicates the word "phase".



This symbol indicates the principal on/off switch is in the "ON" position.



This symbol indicates the principal on/off switch is in the "STANDBY" position.

## 2-4 Front Panel

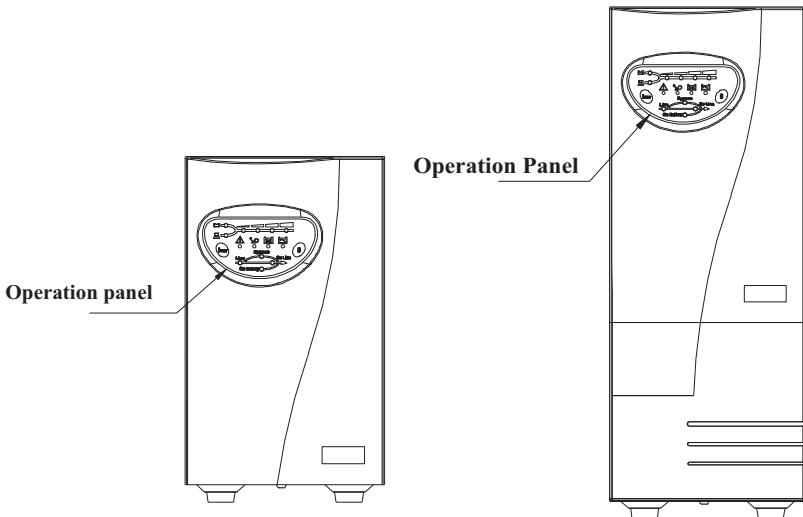

Fig 2-1.1 Front Panel for 1KVA

Fig 2-1.2 Front Panel for 2KVA or 3KVA

## 2-5 Operation Panel

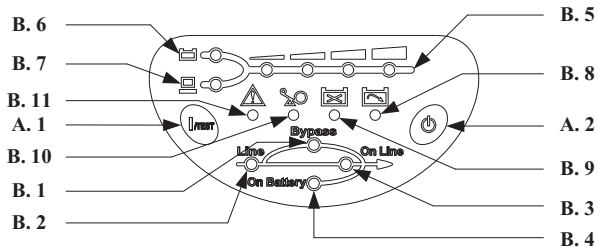



Fig 2-2 Operation Panel

## OPERATION PANEL

### A. Button:

-  : **TEST**: The button is used for turning on the UPS, it also can perform the test function in **"ON-LINE mode"**. In backup mode, this button can turn off the buzzer for silence.
-  : The button is used for turning off UPS.

### B. LED display:

- Bypass**: The LED indicates UPS in **"BYPASS mode"**.
- Line**: The LED indicates the condition of UPS input line. If the input voltage is too low, too high or out of frequency this LED will flash. When line is blackout or ultra high voltage (>300Vac), this LED will light off.
- ON Line**: The UPS is running in **"ON-LINE mode"**.
- ON Battery**: The UPS is running in **"ON-BATTERY mode"** (backup mode), the internal batteries supply power.



- Level LEDs**: The four LEDs indicate the battery capacity in **"ON-BATTERY mode"** or UPS load percentage in **"ON-LINE mode"**.



- Battery**: "Level LEDs" shows the current battery capacity when the LED lights up.



- Load**: "Level LEDs" shows the UPS load level when the LED lights up.



- Battery low**: The LED indicates the battery in battery low condition.



- Battery replace**: The LED indicates the batteries are weak and suggest the user to replace the batteries.



- Overload**: The LED indicates UPS' load exceed the rating, after a limited period, the UPS will transfer to **"BYPASS mode"** and the LED will still light on to alarm the user.



- Fault**: The LED indicates that the UPS is fault. The LED Flash indicates that the UPS is overheat.

## 2-6 Rear Panel

The rear panel is explained as follows: (Please refer to fig 2-3, 2-4)

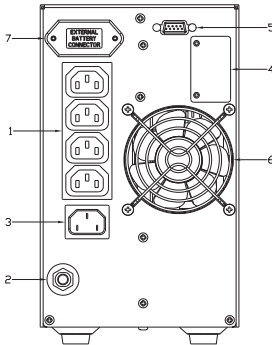

Fig 2-3 (1KVA)

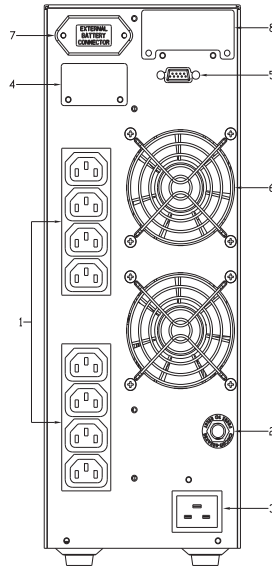

Fig 2-4 (2KVA/3KVA)

1. **OUTPUT RECEPTACLES:** The UPS supplies AC power to the load via these receptacles.
2. **I/P BREAKER:** This is used to prevent high input current from the UPS.
3. **INPUT SOCKET:** AC input utility power supplies to the UPS via the socket.
4. **TVSS (Transient Voltage Surge Suppressor) (RJ-45/RJ-11 SURGE PROTECTOR):** These connectors are used to prevent damage from surge, noise and spike traveling from telephone or network line.
5. **COMMUNICATION INTERFACE (RS-232):** The communication port is used to communicate PC and UPS. Please refer to section 8 for more information.
6. **Fan:** DC fans for cooling purpose.
7. **External Batteries Connector:** Used for connecting external battery cabinets to extend back up time.
8. **SNMP SLOT:** SNMP adapter can be inserted into this port for monitoring UPS status via network.

## 3. INSTALLATION

### 3-1 Unpacking



- Please read this user manual before installing the UPS.
- This UPS contains batteries which are potentially hazardous to user, even when the UPS is not connected to the utility power.
- Before unpacking the UPS, check the packing box. If there are any visible damage, contact your dealer at once.
  - This unit is to operate by any individuals with previous training.
  - This unit should be installed by service personnel.

The UPS package contains the following items. Please check if any items are missing. If there is any damage or anything missing, please immediately contact the dealer from whom you purchased the unit.

No.	Item	Quantity
1	UPS	1 pc
2	User Manual	1 pc
3	RS232 Cable	1 pc
4	Power Cord	2 pcs
5	Tower Stand (Just GES202N200035 & GES302N200035 have tower stand)	1 set
6	UPS Test Report	1 pc
7	Caution Letter	1 pc
8	Software CD: UPSentry Smart 2000	1 pc
9	Series Number Label	3 pcs

### 3-2 Before Installation



- Avoid exposing the UPS to direct sunlight or other heat source. The UPS should be facing away from direct sunlight glare.
- Choose a well-ventilated area to position your UPS to allow adequate dissipation of heat.
- Ensure the UPS surrounding area is clean and free from moisture.
- Do not put heavy objects on the cable or power cord.

### 3-3 Installation

**Notice:**

- AC output need a disconnect device such as a breaker which has to be provided by others.
- The wire length of output power cord connected to the output receptacle or pressure terminal should be less than 10 meters.
- The UPS provide with pressure terminal connector for field installed wiring, the terminal connector should be applied a 13.8 lb-in (1.554 N-m) of tightening torque.
- The over current protection and short circuit protection for the AC output is provided by internal circuits of UPS and breaker.
- Concerning about the battery voltage, ambient temperature and other specifications of the UPS, please refer to the specification section of this manual.
- Servicing of batteries should be performed or supervised by personnel knowledgeable of batteries and the required precautions. Keep unauthorized personnel away batteries.
- When replacing batteries, replace with the same type and number.

#### 1. Connecting to utility power (Refer to Fig 3-3)

- Connect the BS546 plug of power cord to the BS546 connector on the UPS.
- Plug the other end of the power cord into a two-pole, three-wire, grounding receptacle only. Avoid using extension cords and adapter plug.
- Turn on the input breaker (if the breaker can be turned on) on the rear panel of UPS.
- After that, the fan (in rear panel) will run and all LEDs will light for about 2-3 sec. Meanwhile the CPU inside the UPS setups the initial parameters. User also can check whether all LEDs are normal or not. The UPS is set in "STANDBY mode" initially, after a 'bee' is heard, the load LED lights on and the line LED shows AC utility status. Shown as fig 3-1.

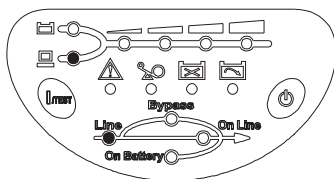

Fig 3-1 Stand-By Mode

## 2. Charging the battery

- The battery charger of the UPS automatically charges the battery whenever the power cord of UPS is connected to a acceptable utility power.
- When UPS is running for the first time, charge the UPS for at least 6 hours to ensure batteries inside are fully charged before operation.
- You may immediately use the UPS without having to wait for the batteries to be fully charged. However, it is advisable not to do this as UPS will have a shorter back-up time than expected if such action is taken.

## 3. Connecting the battery bank

- Utilize the battery connection cable packed with the battery bank.
- Connect on one end of the cable to the external battery connector of UPS, and the other end to that of the battery bank.
- Warning: For safety reason, the manufacturer suggests that ONE UPS CONNECTS AS MANY AS FIFTEEN EXTERNAL BATTERY BANKS.
- The battery banks should be installed by service personnel.
  - ※ According to UL 1778 safety requirement: in order to remove the battery power cord emergently, please plug in the power cord directly.
  - ※ According to EN50091-1-1 safety requirement: beside plugging in the battery power cord, the battery power cord need to be fixed with the screws.

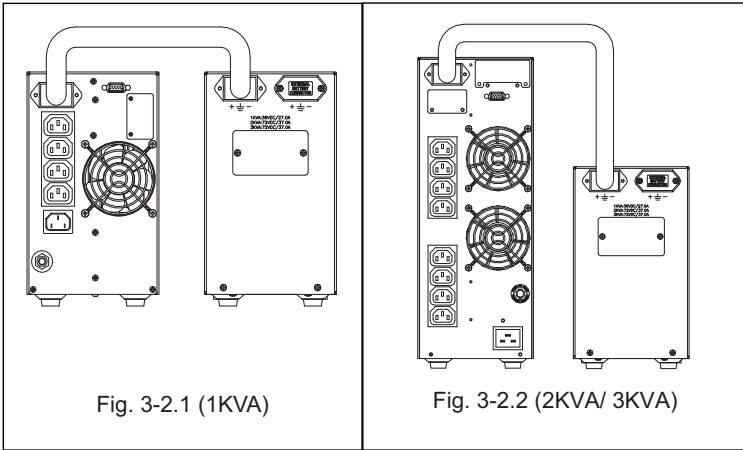

Fig. 3-2 UPS Connected to External Battery Bank

#### 4. Connecting the load

- Calculate power consumption of your loads to ensure that the overload condition will not happen.
- Plug the power cord of the equipment into the output receptacles on the rear panel of the UPS.
- Turn on the equipment connected to the UPS.



- Caution: Do not connect a laser printer to the UPS.
- Caution: Do not connect the UPS to generator.

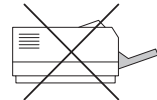

#### 5. Connecting the RS-232

- Connect the interface signal cable between the RS-232 port on the rear panel of UPS and COM1 or COM2 of computer if necessary.
- The D-sub 9 connector can work as a RS-232 communication port depending on the type of cable and software used. Refer to section 8 for more information.



Fig.3-3.1

UPS Connection for 1KVA:

- (1) Connected to RS-232 cabl
- (2) Provides power to PC.
- (3) Connected to utility power.

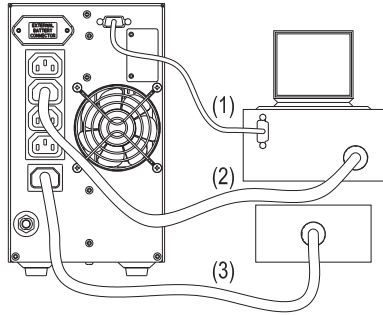

Fig 3-3.1

Fig 3-3.2

UPS Connection for 2KVA or 3K

- (1) Connected to RS-232 cabl
- (2) Provides power to PC.
- (3) Connected to utility power.

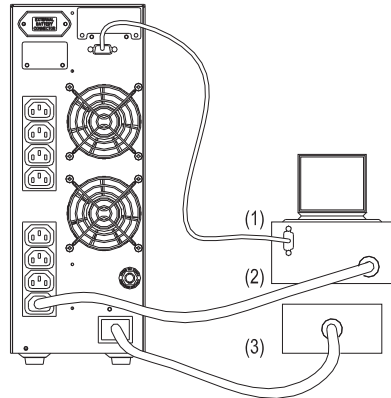

Fig 3-3.2

## 4. OPERATION

### 4-1 Cold start when utility is not present

Even when there is no utility power, you can still turn on the UPS. Just press the 1/TEST button and hold for 2~4 second, the UPS will start up after you hear a “bee”. The battery LED and on-battery LED will light on and the UPS runs on “ON-BATTERY mode”. Shown as fig 4-1.

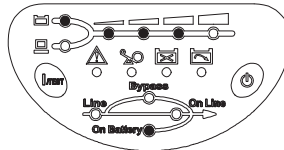

Fig 4-1 On Battery Mode

### 4-2 Turning “ON” the UPS

When the utility power is acceptable for the UPS, you can normally turn on the UPS after pushing the 1/TEST button and hold a few seconds until a “bee” is heard. The bypass LED will extinguish after shortly light on. When the on-line LED lights on, the UPS is running on “ON-LINE mode”. Shown as fig 4-2.

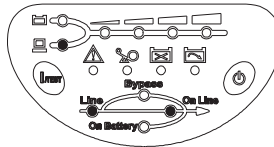

Fig 4-2 On-Line Mode

### 4-3 Turning “OFF” the UPS

Push the 0 button for turning off the UPS, when a “bee” is heard release your press. After a few seconds the UPS is off.

The UPS will keep charging when UPS is in “STANDBY mode” even though the 0 button has been pressed. To fully turn off the UPS, it is advised to unplug the power cord. Refer to fig 3-1.

#### 4-4 UPS self-test

If press the 1/TEST button when the UPS is in “ON-LINE mode”, it will make the UPS shift to 【ON-BATTERY mode】 and automatically perform a self-test for about 10 seconds. (Shown as fig 4-3.) The self-test function will check the condition of the battery. After self-test is finished and test is O.K, the UPS will return to 【ON- LINE mode】 .

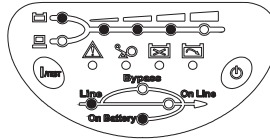

Fig 4-3 UPS Self-Test

#### 4-5 Silence function

The buzzer can be turned “On” or “Off” by toggling the 1/TEST button when the UPS is in 【ON-BATTERY mode】 .

#### 4-6 Abnormal condition

If certain abnormal condition occurs, the UPS will send the following messages:

- ✓ ON-BATTERY mode: When the UPS is in 【ON-BATTERY mode】 , the on- battery LED will light on, buzzer beep half second every 2 seconds and then the UPS will start supplying power to load through batteries. Shown as fig 4-4.

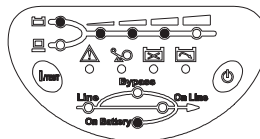

Fig 4-4 On-Battery Mode

- ✓ OVERLOAD: If the load exceeds the UPS rating, after a limited period, the overload LED will light on and buzzer continuous beeping to alarm the user. The user should unplug some uncritical loads to release the overload condition. Shown as fig 4-5.

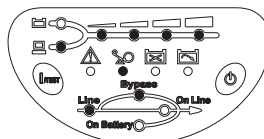

Fig 4-5 Overload and UPS turn into Bypass

- ✓ **BATTERY REPLACE:** This LED function is to alert user that the batteries should be replaced. When the microprocessor in the UPS detects a battery fault, the UPS alarm will give out three beeps. Each beep lasts for 0.5 seconds and interrupted by an interval of 0.5 seconds. After the initial 3 beeps, the alarm will continue to sound every one hour. Shown as fig 4-6.

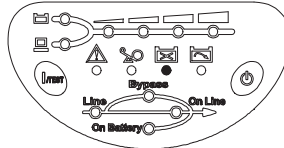

Fig 4-6 Battery Replace

- ✓ **BATTERY LOW:** This function is to inform user the remaining power capacity of the batteries. When batteries reach a low level condition, the UPS alarm will beep half second every 1.5 seconds until running out of battery capacity. Shown as fig 4-7.

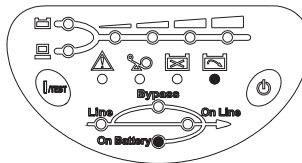

Fig 4-7 Battery Low

- ✓ **SHORT CIRCUIT:** When the output of the UPS shorts in **【ON-LINE mode】** or **【ON-BATTERY mode】**, the UPS will shut down (without output voltage). As soon as the short circuit is happened, the fault LED will light on and the UPS alarm will sound continuously. When remove short circuit, the UPS output will recover. If short circuit is happened in “BYPASS mode”, the UPS will protect itself by tripping the input breaker and shut down. Shown as fig 4-8.

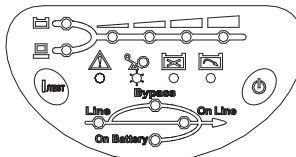
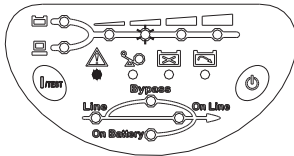

Fig 4-8 Short Circuit

## 4-7 UPS internal fault

If the following conditions occur, the UPS fails. At this time the UPS will transfer to **【BYPASS mode】**. The bypass LED and fault LED will light on and alarm continuously. If utility is too low or too high the UPS output will be disabled. For fault messages, please refer to the troubleshooting (section7) of this manual.

- When the UPS inner component overheats, the UPS will protect itself by thermo-switches. This status is so-called (“**O.T.P**”).
- When under (or over) voltage is happened in the UPS output. This kind of fault will be detected by the microprocessor in the UPS and is so-called “**U.V.P**” (“**O.V.P**”).
- When under (or over) bus voltage is happened in the UPS and is so-called “**Bus U.V.P**” (“**Bus O.V.P**”).



4-9 Output U.V.P

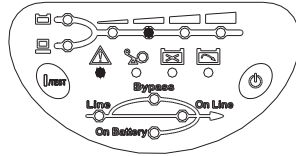

4-10 Output O.V.P

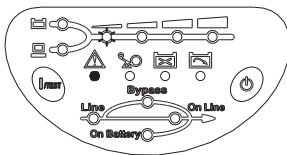

4-11 DC BUS U.V.P

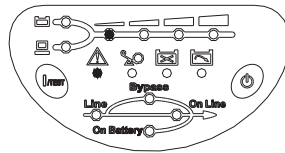

4-12 DC BUS O.V.P

## 4-8 Derating power

In the range of 80Vac to 175Vac, the UPS load capacity will decrease. This function provides a wider operating power voltage range.

## 5. MAINTENANCE

- Normally, the life of battery is 3 years. But extreme operating condition and environment may shorten its life-span.
- To replace batteries, contact qualified personnel.
- When UPS has been unused for a period of time, the batteries will discharge slightly. It is recommended to charge the UPS once every 3 months.
- Use a vacuum cleaner to get rid of any dust that may rest on the opening of the fan.
- Unplug the UPS when it is not used for a long time.
- When cleaning the plastic case or front panel, only use a soft, dry cloth. If the case or front panel is very dirty, use a neutral, non-abrasive detergent. Do not use alcohol or ammonia based solutions.
- When moving your UPS, always handle it with care.
- Avoid spilling liquid on the UPS.
- The equipment should be repaired and installed by individuals with previous training.

When installing this equipment, it should be noted that the leakage current of the UPS and its loads must not exceed 3.5mA in total for safety.

## 6. PLACEMENT

To stably install the UPS of 2 and 3kVA models, you must set up UPS with supporting stands.

The installation method is as shown below:

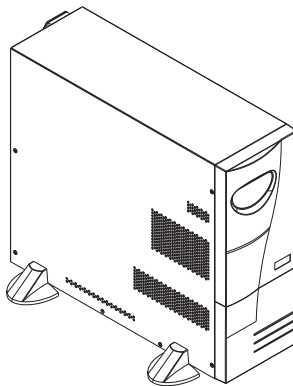

Fig 6-1 Erect the UPS with supporting stands

## 7. TROUBLESHOOTING

Problem	Possible Cause	Solution
UPS is not turned on. (No alarm, No LED lights)	ON/TEST button is not pushed.	Press the 1/TEST button to turn on the UPS. (Refer section 4 to turn on the UPS.)
	Battery low shut down and utility is absent.	Waiting for line recovery.
	The rear panel input circuit breaker is tripped. (Button is tripped out)	1. Reduce some loads connected to the UPS. 2. Reset the circuit breaker. (Push button in)
	UPS fault.	Call for qualified service personnel if above actions do not solve the problem.
UPS does not provide expected back-up time.	Batteries inside the UPS are not fully charged.	Recharge the batteries for at least 8 hours.
	UPS is overloaded.	Remove some unnecessary loads.
	Batteries are weak.	Batteries weak faster when used often or operating at higher temperature. If the battery is near the end of its life, call for service personnel. Replace the battery even if the REPLACE BATTERY LED does not light.
	Charger fault or other reason.	Call for service.
All LEDs light on.	Internal UPS fault.	1. Turn off UPS. 2. Call for service.
“REPLACE BATTERY” LED lights on.	Weak batteries.	1. Recharge the batteries for at least 8 hours. 2. If problem remains Call for service personnel to, replace the batteries.
PC-UPS communication does not work properly.	Incorrect transmission speed.	Re-test after using another different transmission speed.
	Incorrect RS-232 connection.	Refer to communication interface (Section 8) of this manual Re-connect the UPS with COM1 / COM2 on PC again.
UPS operates on battery even though the line is in normal operating condition.	No incoming utility.	Check input power connection.
	The rear panel input circuit breaker is tripped. (Button is out).	1. Reduce some loads connected to the UPS. 2. Reset the circuit breaker. (Push button in)
	Very high, low or distorted utility voltage.	Have qualified electrician check the input voltage.
Site wiring fault LED (fault led flash).	Wiring error such as reversed hot/neutral.	Get wiring checked by electrician.
UPS over temperature.	The exhaust fans and ventilation grills may be obstructed.	Choose a well-ventilated area to position your UPS to allow adequate dissipation of heat.
	The environment temperature exceeds 40°C (104°F).	Position your UPS in cooler area.
“FAULT”LED lights on, alarm beeps	UPS failure.	Call fore service engineer.
“OVERLOAD” LED lights on and buzzer beeps continuously.	Overloaded.	Remove some critical load.

## 8. COMMUNICATION INTERFACE

The UPS provides **RS-232** protocols in one D-sub 9 connector. Using proper UPS management software and cable, the UPS can be managed over LAN/intranet/internet environment. The pin assignment of the D-sub 9 connector is defined as follows:

PIN	ASSIGNMENT DESCRIPTION		PIN
	RS-232		
1		GND	5
2	UPS TxD(typical RS-232 level)		6
3	UPS RxD(typical RS-232 level)	Reserved for PNP	7
4			8
			9

### 8-1 RS-232

- Pin2 : PC receives line **RS-232** data from UPS.
- Pin3 : PC transmits line **RS-232** data to UPS.
- Pin5 : Signal ground.
- Pin7 : Reversed for plug and play function.

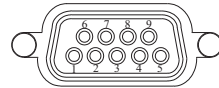

Fig 8-1 Pin Assignment

The **RS-232** communication port provides the following functions:

- 1) Monitoring charger status
- 2) Monitoring battery status and condition
- 3) Monitoring inverter status
- 4) Monitoring UPS status
- 5) Monitoring the utility status
- 6) Providing the power switch function for computer to turn on/off the utility on schedule for power saving
- 7) Adjustable Transfer voltage

The UPS data is provided at 2400 bps baud rate and made up of 8-bit, 1 stop-bit and no parity bit. All information is encoded in ASCII format.

#### HARDWARE:

- BAUD RATE-----2400 bps
- DATA LENGTH-----8 bits
- PARITY-----NONE
- STOP BIT-----1 bit

**CABLING:**Standard D-sub 9 cable (UPS side: male, PC side: female)



## 9. Technical specifications

Model		GES102N	GES202N	GES302N
<b>Capacity</b>		1KVA/700W	2KVA/1400W	3KVA/2100W
Input	Rated Voltage	230V		
	Voltage Range	175V~280V(Full Load); 80V~175V(100% to 50% Load de-rating Linearly)		
	Frequency	50/60Hz (± 5.0 Hz)		
	Power Factor	≥0.97		
Output	Voltage	230V		
	Frequency	50/60Hz		
	Voltage Regulation	+2%		
	Frequency Accuracy	+0.05 Hz		
	Wave Form	Pure Sine Wave		
	Transient Response	+8% (10%~90% Linear Load)		
	THD	≤3%(Linear Load); ≤6%(Computer Load)		
	Overload Capacity	105%-125% for 3mins; 125%-150% for 30secs; >150% for 1sec		
	Crest Factor	3:1		
	Efficiency (AC-AC)	≥ 87%		
Outlet	Receptacle	IEC320x4x1	IEC320x4x2	
Battery	Battery Voltage	36 V	72V	72V
	Battery Type (Lead acid)	12V/ 7Ah		12V/ 9Ah
	Back-up Time (Typical)	5mins (700W)	5mins (1400W)	5mins (2100W)
	Recharge Time	8 Hours After Complete Discharge to Recover 80%	8 Hours After Complete Discharge to Recover 90%	
Transfer Time	Transfer Time	0 ms		
LED	LED Status	On-line、Bypass、On-battery、Overload、Battery Low、Fault、 Battery Replace、Battery Level、Load Level		
	Alarm	Buzzer		
Interface	DB9	RS232		
	SNMP Slot	External	Internal	
Environment	Noise (At 1 Meter)	40dBA	47dBA	
	Operating Temperature	0-40℃		
	Humidity	0%~90% (Non-Condensing)		
Safety Approval	Safety	CE		
	EMC	CISPR22:2009 Class B		
Others	Battery Start	Yes		
	Extendable Battery Bank	Yes		
	Long Time Model	Yes (Optional)		
Appearance	Dimension (W×D×H)	140 x 363 x 242/ mm 5.5 x 14.2 x 9.5/inch	140 x 422 x 373 / mm 5.5 x 16.6 x 14.7 / inch	
	Weight	Typical	15kg / 33 lb	
		Long Time	6kg/ 13.2 lb	
			15.2kg/33.5 lb	

\* All specifications are subject to change without prior notice.

## Warranty

Seller warrants this product, if used in accordance with all applicable instructions, to be free from original defects in material and workmanship within the warranty period. If the product has any failure problem within the warranty period, Seller will repair or replace the product at its sole discretion according to the failure situation.

This warranty does not apply to normal wear or to damage resulting from improper installation, operation, usage, maintenance or irresistible force (i.e. war, fire, natural disaster, etc.), and this warranty also expressly excludes all incidental and consequential damages.

Maintenance service for a fee is provided for any damage out of the warranty period. If any maintenance is required, please directly contact the supplier or Seller.

**WARNING :** The individual user should take care to determine prior to use whether the environment and the load characteristic are suitable, adequate or safe for the installation and the usage of this product. The User Manual must be carefully followed. Seller makes no representation or warranty as to the suitability or fitness of this product for any specific application.



